

HTP ERGONOMIZER

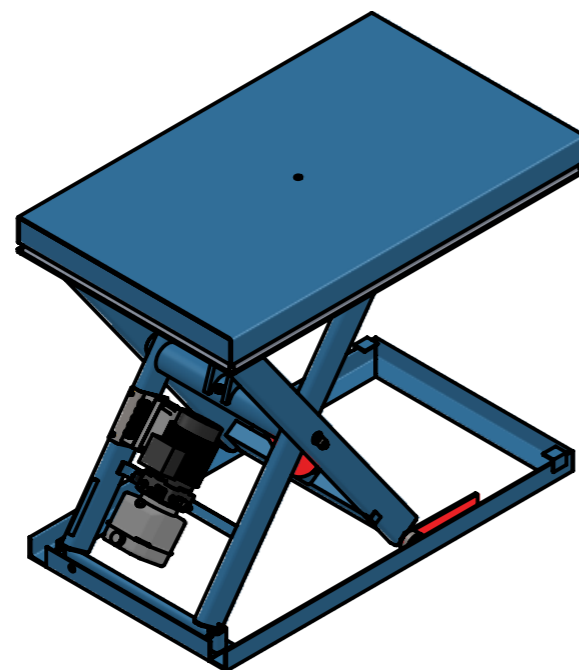
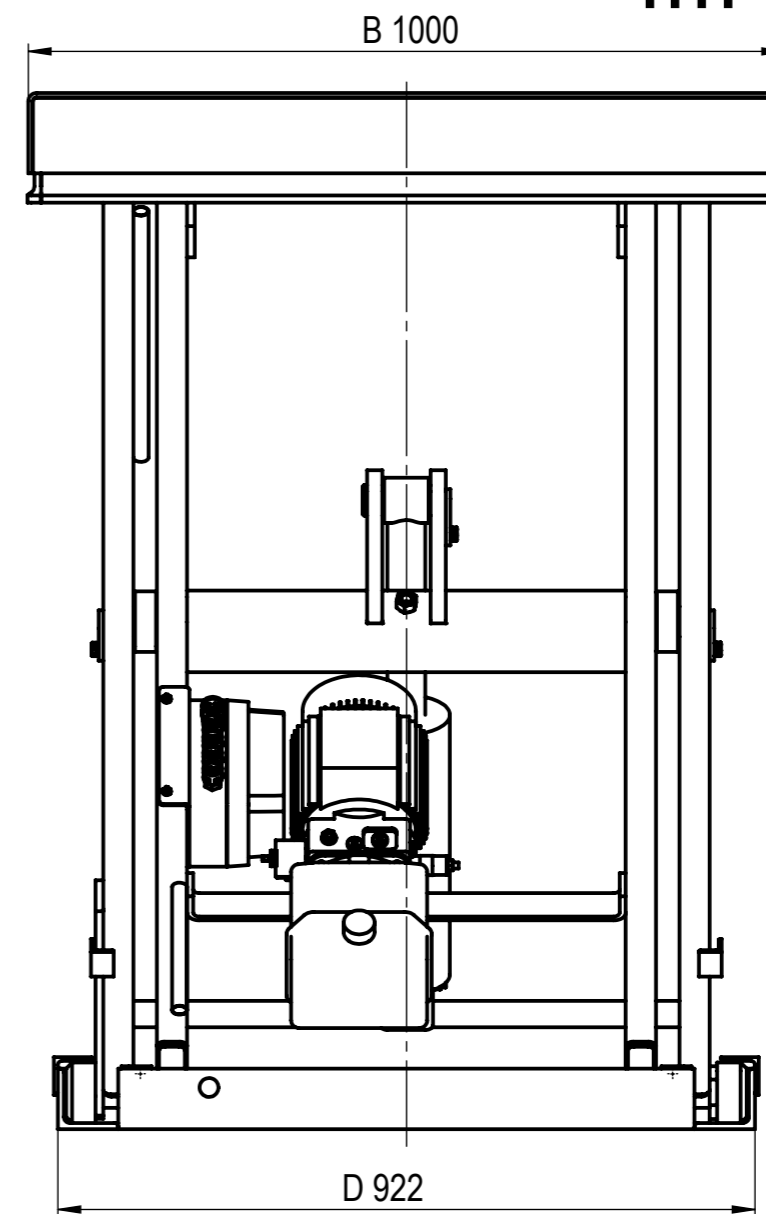
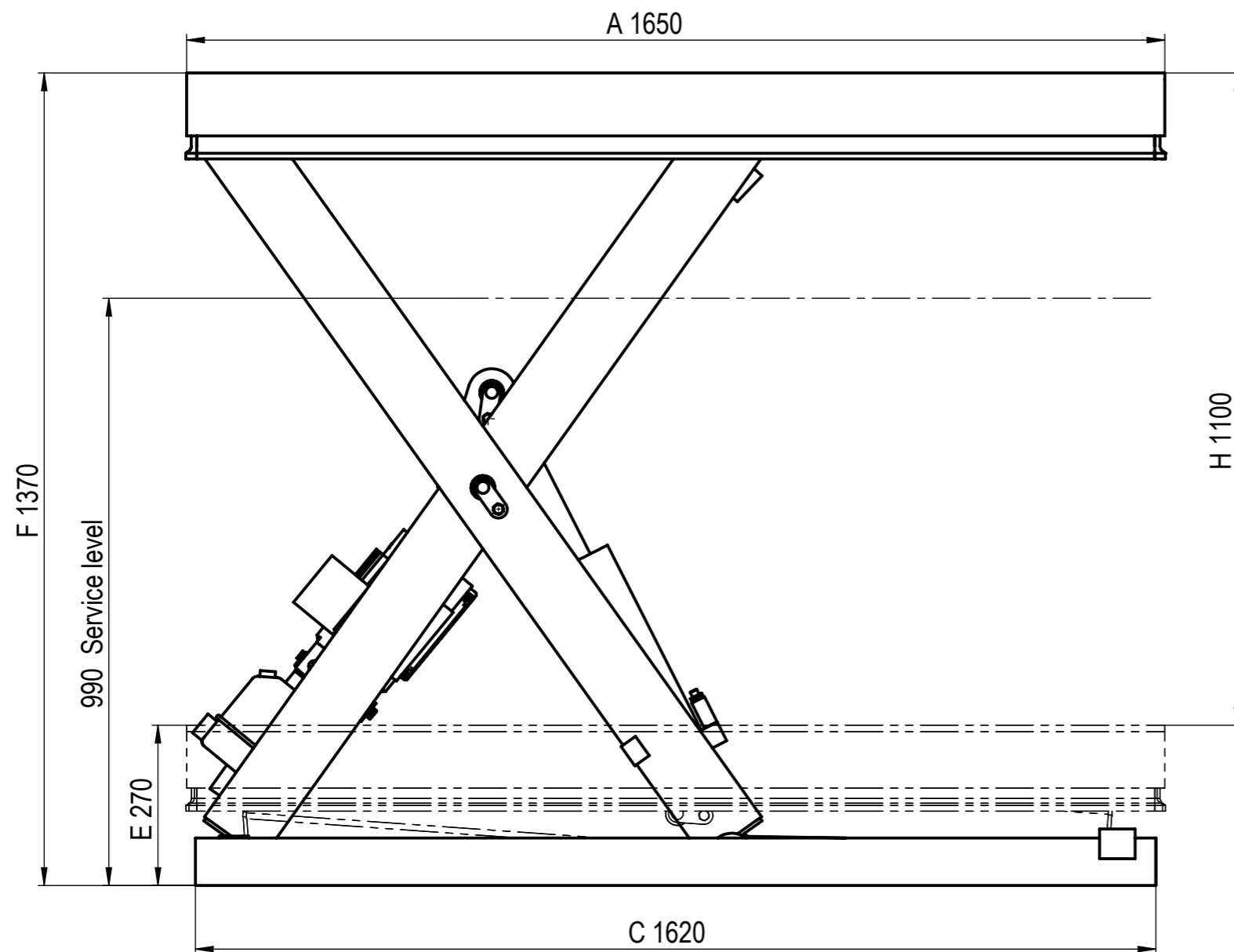

Subject to change. | Änderungen vorbehalten. | Sous réserve de modifications.

Capacity / Tragfähigkeit / Capacité (Full surface load / Flächenlast / Pleine charge de surface)	2000	[kg]
Max Lifting / Max Hub / Hauteur de Levage max	1100	[mm]
Lifting Time / Hubzeit / Temps de course	30	[sek]
Required Power / Motorleistung / Puissance Moteur	1,5	[kW]
Power Supply / Stromversorgung / Tension d'alimentation	3x400V 50Hz	
Lifting Category / Hubkategorie / Catégorie de Levage	2	
Class of Protection / Schutzklasse / Classe de protection	IP54	
Color / Farbe / Couleur	RAL 5015	

		Part name			Quantity:	
		HTP 20 - 1100 1650x1000				
		Drawing nr			Weight:	
		0142.17 00-00 HTP-20-1100 -K13			370kg	
	Dimension in	Sheet	Size	Scale	Index	Date
	mm	1 / 2	A3	1:10	MK	2017-10-16
General tolerances for nominal dimension without specified tolerance: IT 13 The Information Contained In This Drawing Is The Sole Property Of Columbus Mckinnon Corporation. Any Reproduction In Part Or As A Wholewithout The Written Permission Of Columbus Mckinnon Corporation Is Prohibited.						

HTP ERGONOMIZER

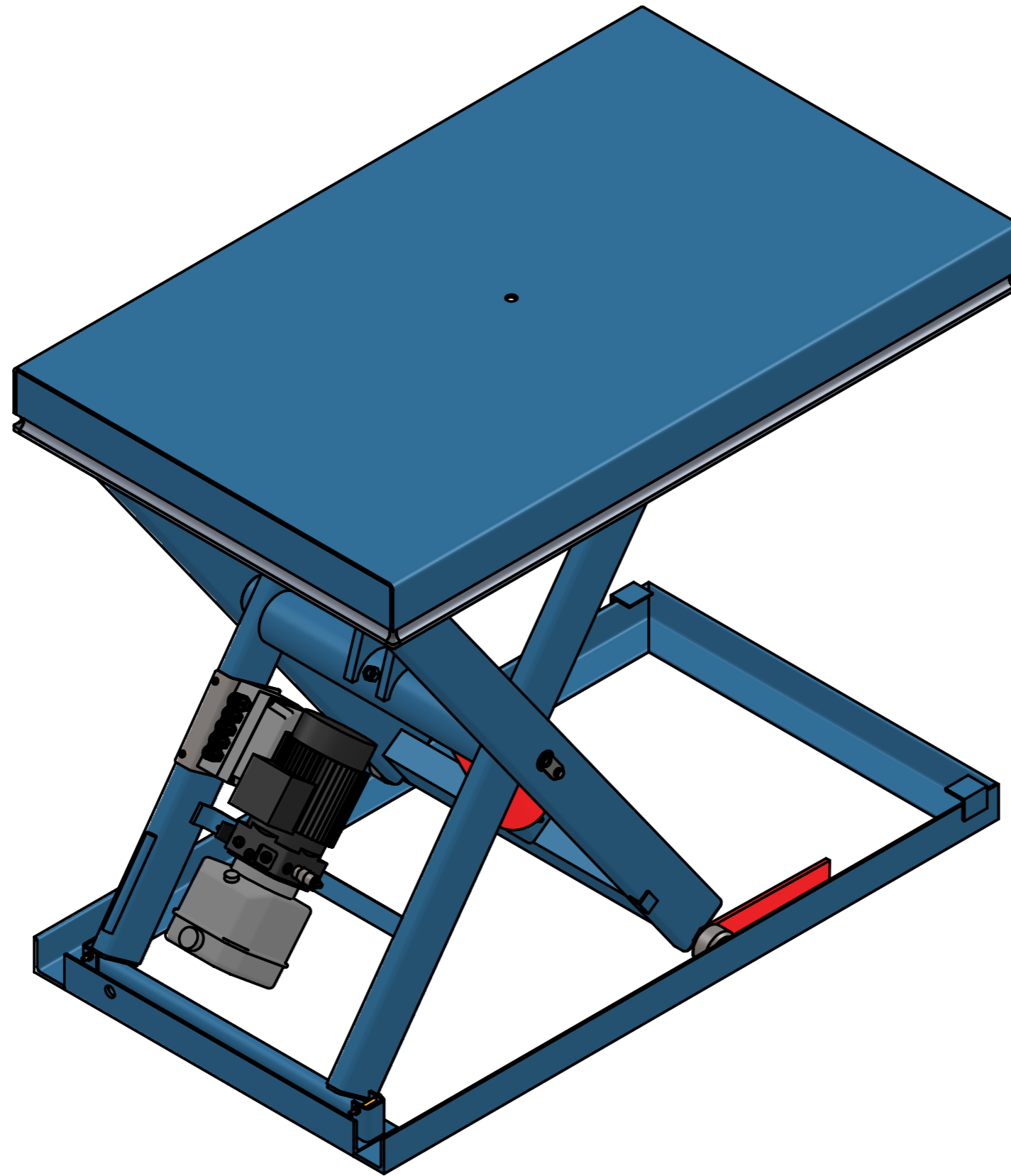

Subject to change. | Änderungen vorbehalten. | Sous réserve de modifications.

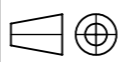
		Part name				Quantity:	
		HTP 20 - 1100 1650x1000					
		Drawing nr				Weight:	
		0142.17 00-00 HTP-20-1100 -K13				370kg	
Dimension in	Sheet	Size	Scale	Index	Date		
mm	2 / 2	A3	1:10	MK	2017-10-16		
<small>General tolerances for nominal dimension without specified tolerance: IT 13 The Information Contained In This Drawing Is The Sole Property Of Columbus McKinnon Corporation. Any Reproduction In Part Or As A Whole Without The Written Permission Of Columbus McKinnon Corporation Is Prohibited.</small>							