

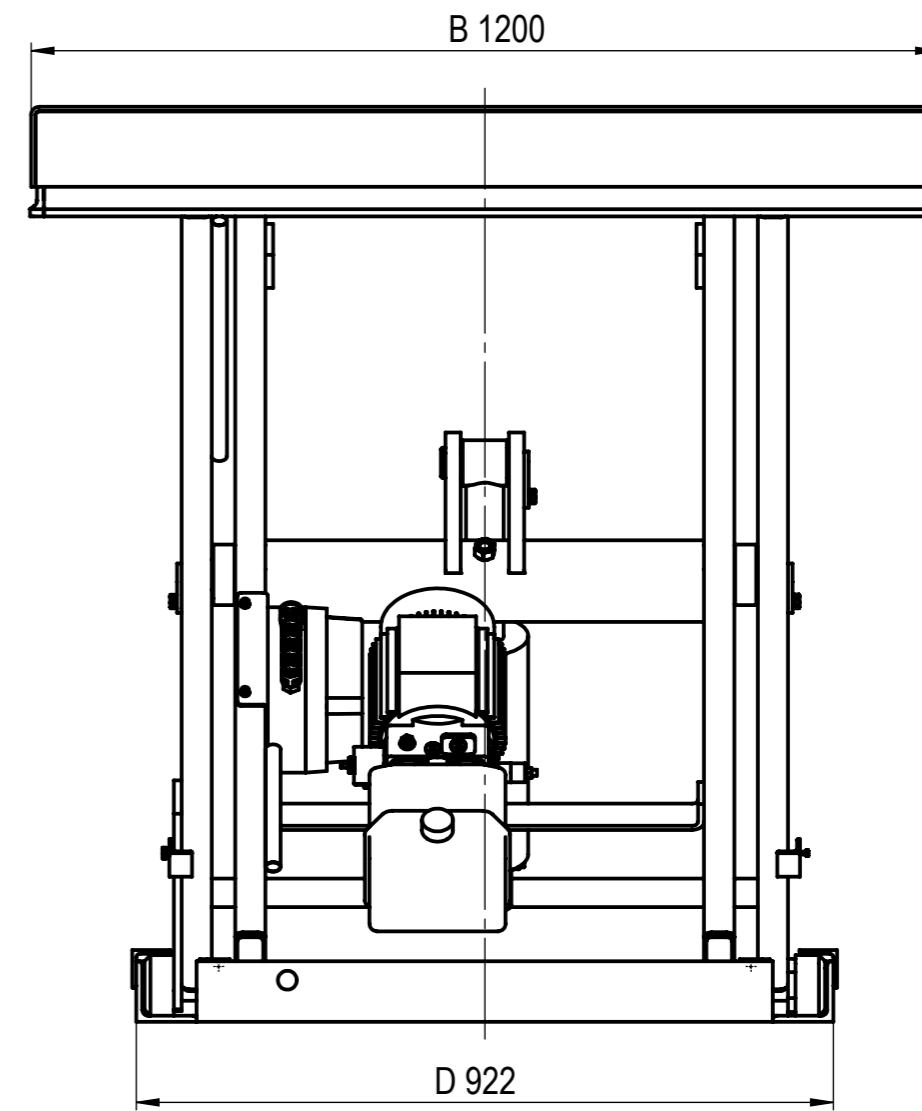

# HTP ERGONOMIZER

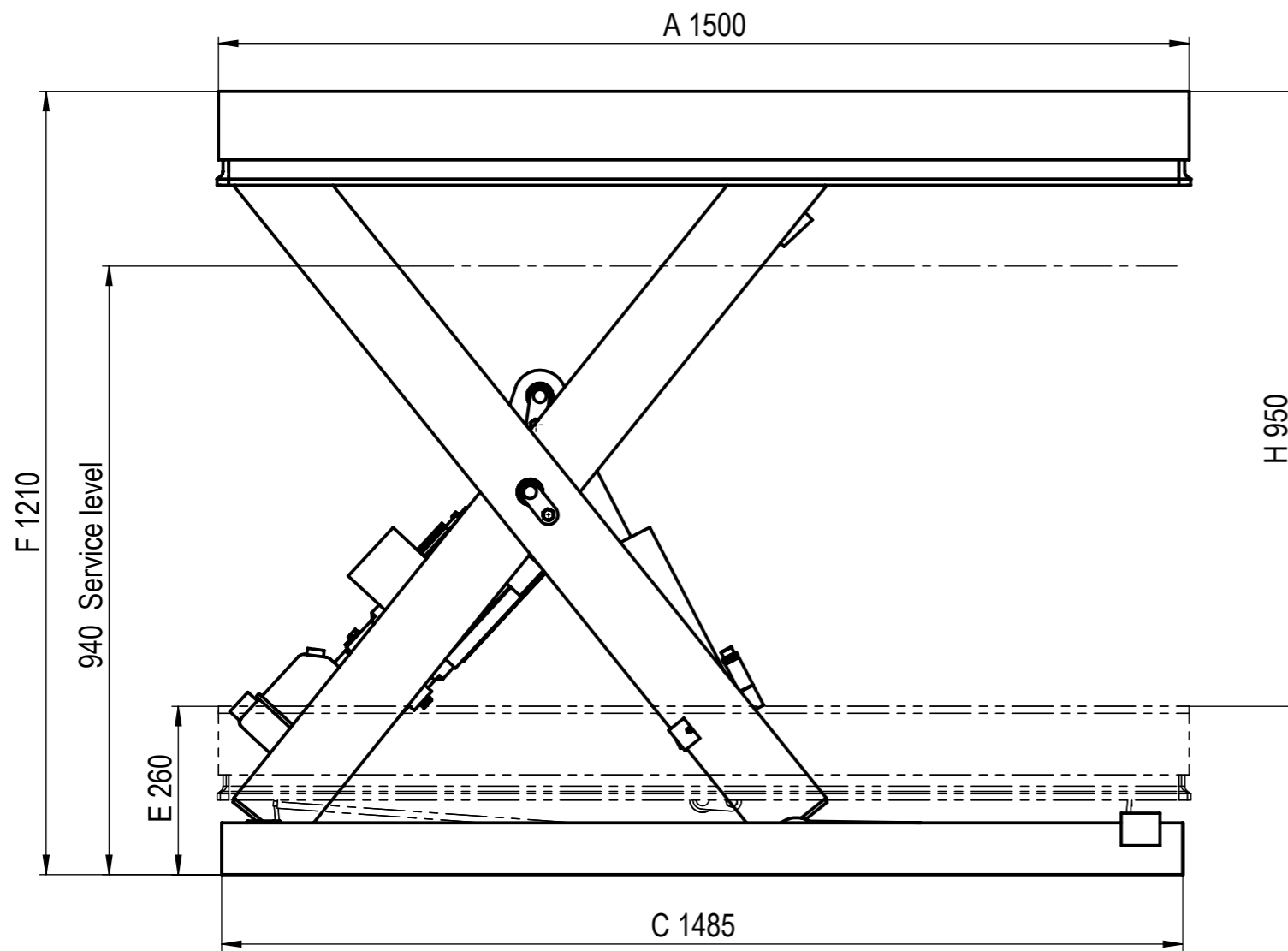

Subject to change. | Änderungen vorbehalten. | Sous réserve de modifications.

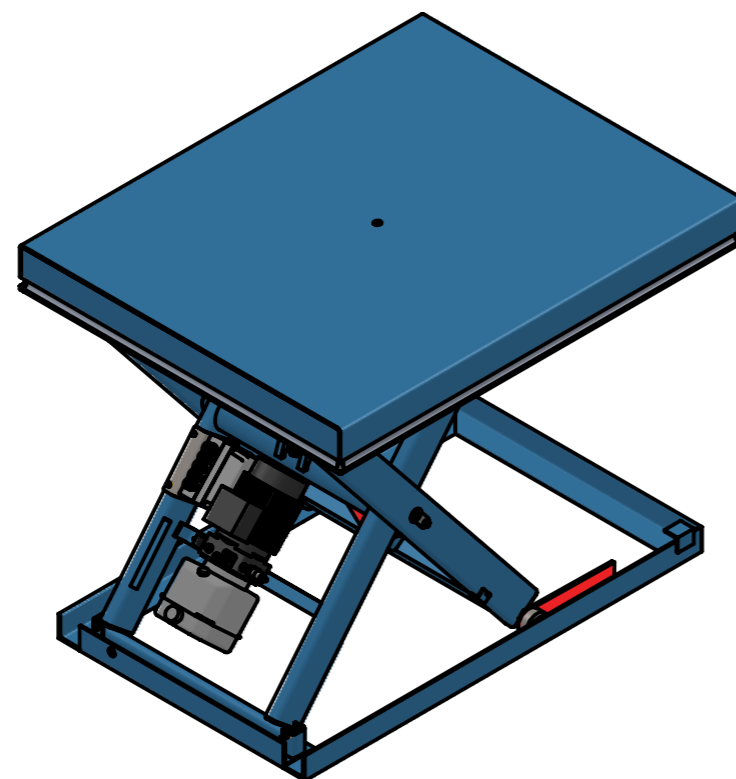

Capacity / Tragfähigkeit / Capacité (Full surface load / Flächenlast / Pleine charge de surface)	2000	[kg]
Max Lifting / Max Hub / Hauteur de Levage max	950	[mm]
Lifting Time / Hubzeit / Temps de course	25	[sek]
Required Power / Motorleistung / Puissance Moteur	1,5	[kW]
Power Supply / Stromversorgung / Tension d'alimentation	3x400V 50Hz	
Lifting Category / Hubkategorie / Catégorie de Levage	2	
Class of Protection / Schutzklasse / Classe de protection	IP54	
Color / Farbe / Couleur	RAL 5015	

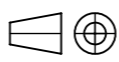
		Part name			Quantity:		
		HTP 20 - 950 1500x1200					
		Drawing nr			Weight:		
		0121.17 00-00 HTP-20-950 -K13			362kg		
	Dimension in	Sheet	Size	Scale	Index	Date	
	mm	1 / 2	A3	1:10	MK	2017-10-16	
<small>General tolerances for nominal dimension without specified tolerance: IT 13 The Information Contained In This Drawing Is The Sole Property Of Columbus McKinnon Corporation. Any Reproduction In Part Or As A Whole Without The Written Permission Of Columbus McKinnon Corporation Is Prohibited.</small>							

# HTP ERGONOMIZER

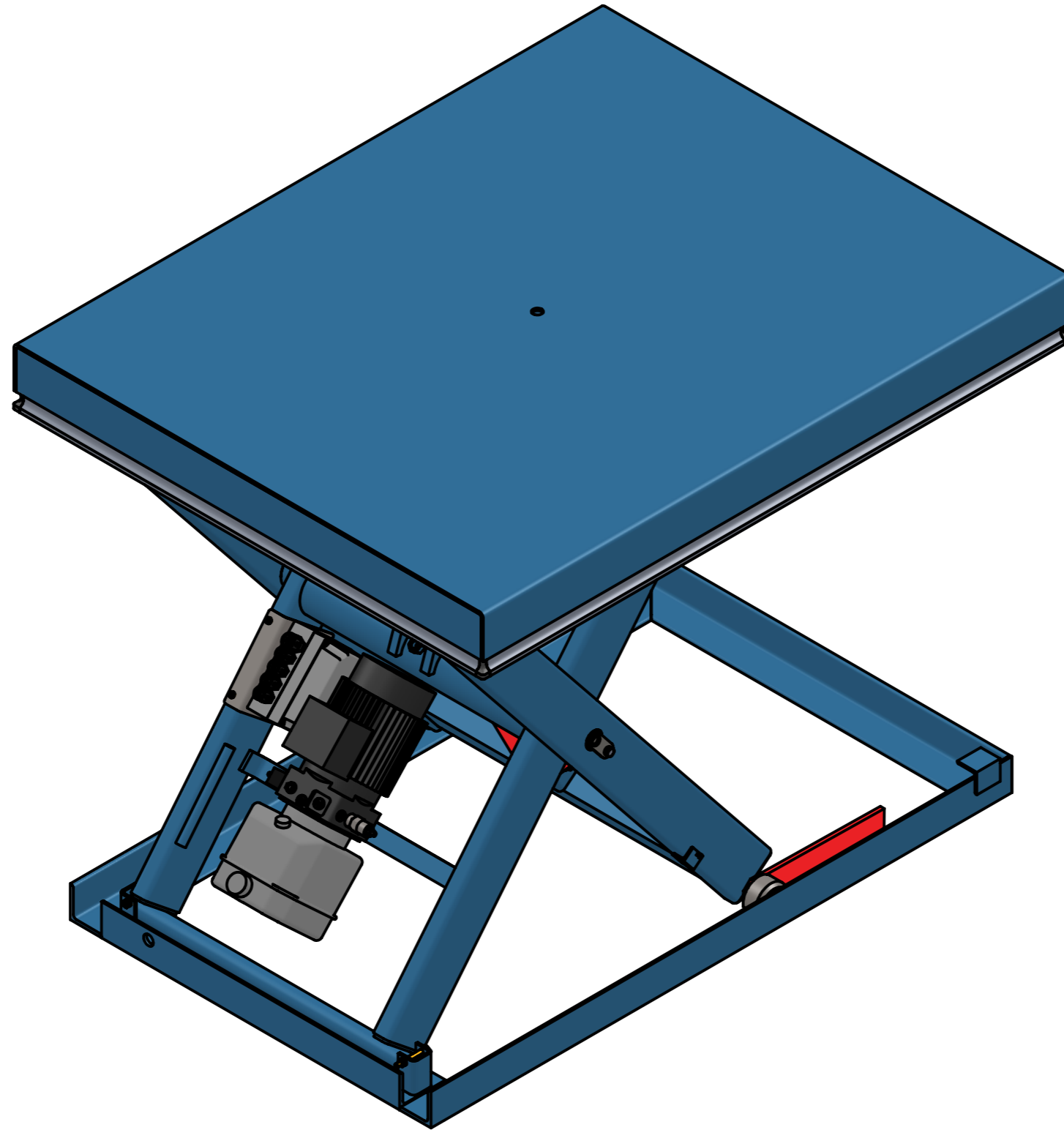

Subject to change. | Änderungen vorbehalten. | Sous réserve de modifications.

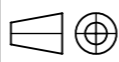
		Part name				Quantity:	
		HTP 20 - 950 1500x1200					
		Drawing nr				Weight:	
		0121.17 00-00 HTP-20-950 -K13				362kg	
	Dimension in	Sheet	Size	Scale	Index	Date	
	mm	2 / 2	A3	1:10	MK	2017-10-16	
<small>General tolerances for nominal dimension without specified tolerance: IT 13 The Information Contained In This Drawing Is The Sole Property Of Columbus Mckinnon Corporation. Any Reproduction In Part Or As A Wholewithout The Written Permission Of Columbus Mckinnon Corporation Is Prohibited.</small>							